

Shop Online

Website

www.store.siyiamerica.com



LinkedIn

@siyi-america



Facebook

@siyihardware



Instagram

@siyi_america

Showroom

5910 W by North West, Suite 100,
Houston, TX 77040
(832) 331-8898

info@siyiamerica.com
www.siyiamerica.com

SIYI AMERICA

Functional Hardware

System SKU: SY4803PT



PRODUCT SPECIFICATION:

- Length: 9" (228mm) to 21" (533mm)
- Mounting Type: Undermount
- Closing Type: Soft Close
- Load Capacity: 100lb (45kg) / 18"
- Application: Frameless / Face Frame
- Height of slide: 45mm

Product Parameters

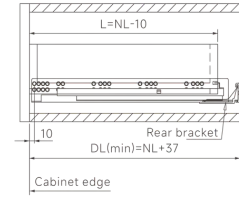

Outset drawer

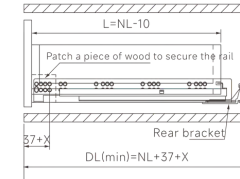

Inset drawer

W:Internal cabinet width
 L:Drawer length
 NL:Assembling dimensions length
 DL:Internal cabinet depth
 X:The drawer board thickness

Installation dimensions

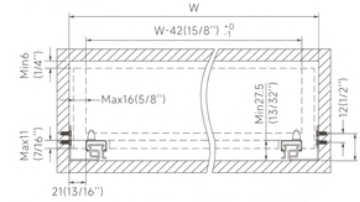

The drawer side thickness of 16mm with locking brackets installation size.

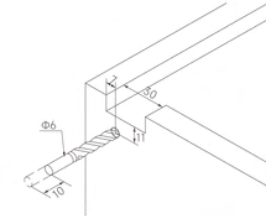

Calculating outside drawer width

For drawer side panel thickness	(5/8")	(9/16")	(1/2")
Deduct from inside cabinet width	(3/8")	(9/16")	(5/8")

Example: For (24") inside cabinet width and a (1/2") thick drawer panel, (24") minus (5/8") = (23 3/8") drawer width

1	1.5	2	3	4	5	5.5	6	7	8	9	9.5	10	11	12	13	13.5	14	15	16	17	17.5	18	19	20	20.5	21	22	23	24	24.5	25	25.5
1/32	1/8	3/32	1/8	5/32	3/16	7/32	1/4	9/32	5/16	11/32	3/8	13/32	7/18	15/32	1/2	17/32	9/18	19/32	5/8	21/32	11/18	23/32	3/4	25/32	13/18	27/32	7/8	29/32	15/18	31/32	1	

Millimeter to inch Conversion Chart

**KCMA-BIFMA-BHMA
 CERTIFIED GRADE - 1**

PRODUCT NAME	SKU
Synchronized Under Mount Slides - PT Series 9" Synchronized Full Extension Under Mount Slides 16MM	SY4803PT-229
Synchronized Under Mount Slides - PT Series 12" Synchronized Full Extension Under Mount Slides 16MM	SY4803PT-305
Synchronized Under Mount Slides - PT Series 15" Synchronized Full Extension Under Mount Slides 16MM	SY4803PT-381
Synchronized Under Mount Slides - PT Series 18" 5/8" Synchronized Full Extension Under Mount Slides	SY4803PT-457
Synchronized Under Mount Slides - PT Series 21" 5/8" Synchronized Full Extension Under Mount Slides	SY4803PT-533

System SKU: SY7816



PRODUCT SPECIFICATION:

- Length: 15" (381mm) to 21" (533mm)
- Mounting Type: Undermount
- Closing Type: Soft Close
- Load Capacity: 75lb (35kg) / 18"
- Application: Frameless / Face Frame
- Height of slide: 45mm
- 10 pairs / box
- Extension 7/8

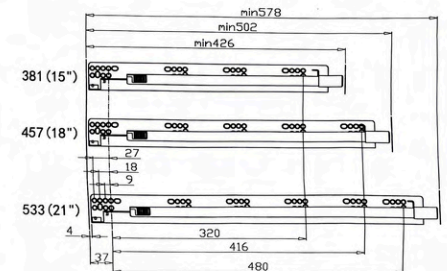
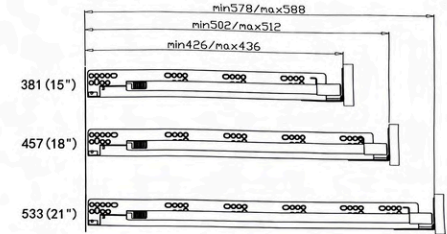
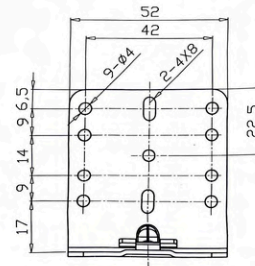
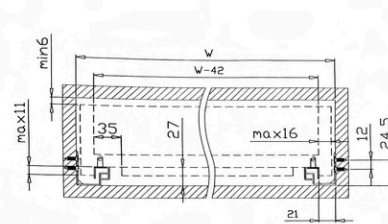

Calculating outside drawer width

For drawer side panel thickness	(5/8")	(9/16")	(1/2")
Deduct from inside cabinet width	(3/8")	(9/16")	(5/8")

Example: For (24") inside cabinet width and a (1/2") thick drawer panel, (24") minus (5/8") = (23 3/8") drawer width

1	1.5	2	3	4	5	5.5	6	7	8	9	9.5	10	11	12	13	13.5	14	15	16	17	17.5	18	19	20	20.5	21	22	23	23.5	24	
1/32	1/18	3/32	1/8	5/32	3/16	7/32	1/4	9/32	5/16	11/32	3/8	13/32	7/18	15/32	1/2	17/32	9/18	19/32	5/8	21/32	11/18	23/32	3/4	25/32	13/18	27/32	7/8	29/32	15/18	31/32	1

Millimeter to inch Conversion Chart

PRODUCT NAME	SKU
15" Full-Access Undermount Slide-Max 16mm Panel	SY7816-381
18" Full-Access Undermount Slide-Max 16mm Panel	SY7816-457
21" Full-Access Undermount Slide-Max 16mm Panel	SY7816-533

Synchronized Undermount Soft Close Slides

System SKU: UM19



Synchronized Undermount Soft Close Slides

PRODUCT SPECIFICATION:

- Length: 18" (457mm) to 21" (533mm)
- Mounting Type: Undermount
- Closing Type: Soft Close
- Load Capacity: 75lb (35kg) / 18"
- Application: Frameless / Face Frame
- Height of slide: 45mm

Product Parameters

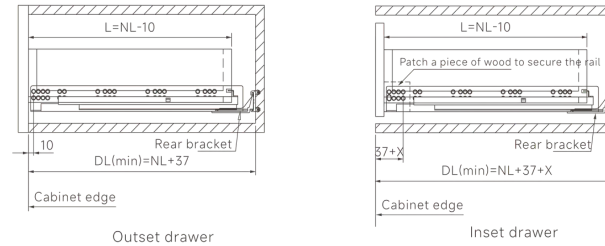

W: Internal cabinet width
 L: Drawer length
 NL: Assembling dimensions length
 DL: Internal cabinet depth
 X: The drawer board thickness

Screw positions of the slides

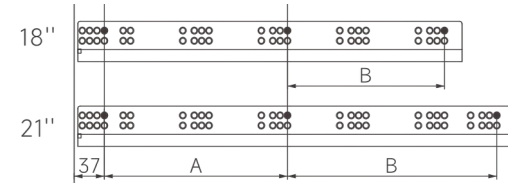

Calculating outside drawer width

For drawer side panel thickness:	(3/4")	(5/8")	(9/16")	(1/2")
Deduct from inside cabinet width:	(3/8")	(5/8")	(13/16")	(7/8")

Example: For (24") inside cabinet width and a (1/2") thick drawer panel, (24") minus (7/8") = (23 1/8") drawer width

1/32	1/16	3/32	1/8	5/32	3/16	7/32	1/4	9/32	5/16	11/32	3/8	13/32	7/16	15/32	1/2	17/32	9/16	19/32	5/8	21/32	11/16	23/32	3/4	25/32	13/16	27/32	7/8	29/32	15/16	1
------	------	------	-----	------	------	------	-----	------	------	-------	-----	-------	------	-------	-----	-------	------	-------	-----	-------	-------	-------	-----	-------	-------	-------	-----	-------	-------	---

Millimeter to inch Conversion Chart

**KCMA-BIFMA-BHMA
 CERTIFIED GRADE - 1**

PRODUCT NAME	SKU
18" Synchronized Undermount Soft Close Slides	UM19-457
21" Synchronized Undermount Soft Close Slides	UM19-533

U-Max Full Extension Soft Close Under Mount Slide

System SKU: ZX5003



U-Max Full Extension Soft Close Under Mount Slide

PRODUCT SPECIFICATION:

- Length: 12" (305mm) to 21" (533mm)
- Mounting Type: Undermount
- Closing Type: Soft Close
- Load Capacity: 75lb (35kg) / 18"
- Application: Frameless / Face Frame
- Height of slide: 45mm

Product Parameters

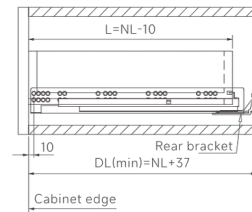

Outset drawer

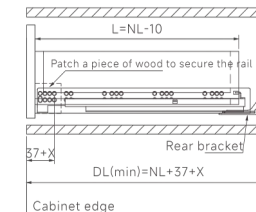

Inset drawer

W: Internal cabinet width
 L: Drawer length
 NL: Assembling dimensions length
 DL: Internal cabinet depth
 X: The drawer board thickness

Screw positions of the slides

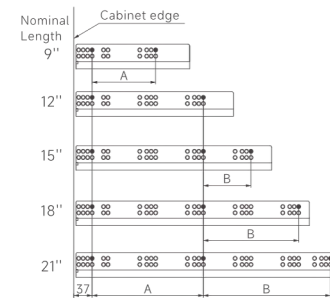

Calculating outside drawer width

For drawer side panel thickness:	(3/4")	(5/8")	(9/16")	(1/2")
Deduct from inside cabinet width:	(3/8")	(5/8")	(13/16")	(7/8")

Example: For (24") inside cabinet width and a (1/2") thick drawer panel, (24") minus (7/8") = (23 1/8") drawer width

1/32	1/16	3/32	1/8	5/32	3/16	7/32	1/4	9/32	5/16	11/32	3/8	13/32	7/16	15/32	1/2	17/32	9/16	19/32	5/8	21/32	11/16	23/32	3/4	25/32	13/16	27/32	7/8	29/32	15/16	31/32	1
------	------	------	-----	------	------	------	-----	------	------	-------	-----	-------	------	-------	-----	-------	------	-------	-----	-------	-------	-------	-----	-------	-------	-------	-----	-------	-------	-------	---

Millimeter to inch Conversion Chart

**KCMA-BIFMA-BHMA
 CERTIFIED GRADE - 1**

PRODUCT NAME	SKU
15" P1 Undermount Soft Close Slides	ZX5003-381
18" P1 Undermount Soft Close Slides	ZX5003-457
21" P1 Undermount Soft Close Slides	ZX5003-533

U-Max Full Extension Soft Close Undermount Slide

System SKU: ZX4801



Calculating outside drawer width

For drawer side panel thickness	(5/8")	(9/16")	(1/2")
Deduct from inside cabinet width	(3/8")	(9/16")	(5/8")

Example: For (24") inside cabinet width and a (1/2") thick drawer panel, (24") minus (5/8") = (23 3/8") drawer width

1	2	3	4	5	6	7	8	9	10	11	12	13	14	15	16	17	18	19	20	21	22	23	24	25	26	27	28	29	30	31	32	33	34	35	36	37	38	39	40	41	42	43	44	45	46	47	48	49	50	51	52	53	54	55	56	57	58	59	60	61	62	63	64	65	66	67	68	69	70	71	72	73	74	75	76	77	78	79	80	81	82	83	84	85	86	87	88	89	90	91	92	93	94	95	96	97	98	99	100
1/32	1/16	3/32	1/8	5/32	3/16	7/32	1/4	9/32	5/16	11/32	3/8	13/32	7/16	15/32	1/2	17/32	9/16	19/32	5/8	21/32	11/16	23/32	3/4	25/32	13/16	27/32	7/8	29/32	15/16	31/32	1																																																																				

Millimeter to inch Conversion Chart

**KCMA-BIFMA-BHMA
CERTIFIED GRADE - 1**

U-Max Full Extension Soft Close Undermount Slide

PRODUCT SPECIFICATION:

- Length: 10" (250mm) to 22" (550mm)
- Mounting Type: Undermount
- Closing Type: Soft Close
- Load Capacity: 75lb (35kg) / 18"
- Application: Frameless
- Height of slide: 45mm
- Max Drawer Side Thickness: 5/8" (16mm)

Product Parameters

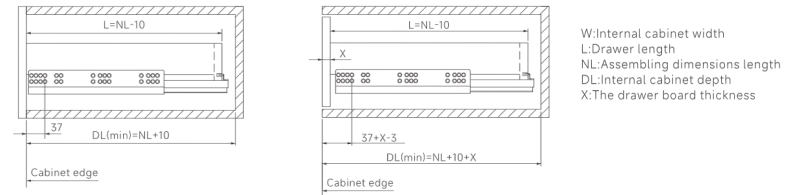

Screw positions of the slides

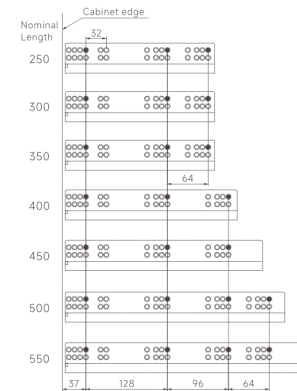

Installation dimensions

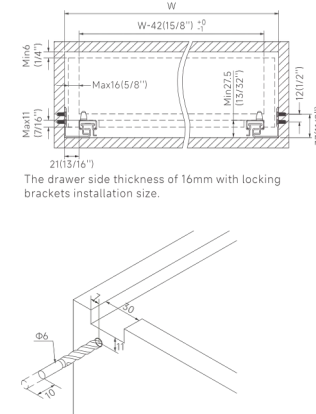

PRODUCT NAME	SKU
P1 Series: 14" EuroMax 16mm Undermount Soft Close Closet Slide	ZX4801-350
P1 Series: 16" EuroMax 16mm Undermount Soft Close Closet Slide	ZX4801-400
P1 Series: 18" EuroMax 16mm Undermount Soft Close Closet Slide	ZX4801-450
P1 Series: 20" EuroMax 16mm Undermount Soft Close Closet Slide	ZX4801-500
P1 Series: 22" EuroMax 16mm Undermount Soft Close Closet Slide	ZX4801-550



UM-RMB-100M

Undermount Rear
Mounting Bracket - Metal



UM-RMB-200P

Undermount Adjustable
Rear Mounting Bracket
(10mm dowel)



UM-RMB-300M (narrow)

Undermount Rear Mounting
Bracket - Metal



UM-RMB-400P

Undermount Adjustable
Rear Mounting Bracket
(8mm dowel)

COMPATIBLE WITH:



UMax Synchronized Under Mount
Slides Soft Close - SY4803PT



UMax 19mm Undermount Slides
P1 - ZX5003



Full-Access Undermount Slides -
SY7816



Synchronized Undermount Soft
Close Slides - UM19

Side-Mount Ball Bearing Slides

System SKU: SY4511



(STANDARD DUTY - 100 LB)

**KCMA-BIFMA-BHMA
CERTIFIED GRADE - 1**

Side-Mount Ball Bearing Slides

PRODUCT SPECIFICATION:

- Material: Cold-rolled steel
- Finish: Zinc plating, Electrophoresis Black Treatment
- Load rating: 100 LB - 45KG (450mm as standard)
- Cycling: 50,000 times
- Thickness: 1.2mm x 1.2mm x 1.5mm
- Size range: 200mm-700mm (8" - 28"), customizable sizes are available
- Assembling: side mounting with screws
- Application: steel furniture, commercial and residential furniture, cabinets, etc.

Drawing description

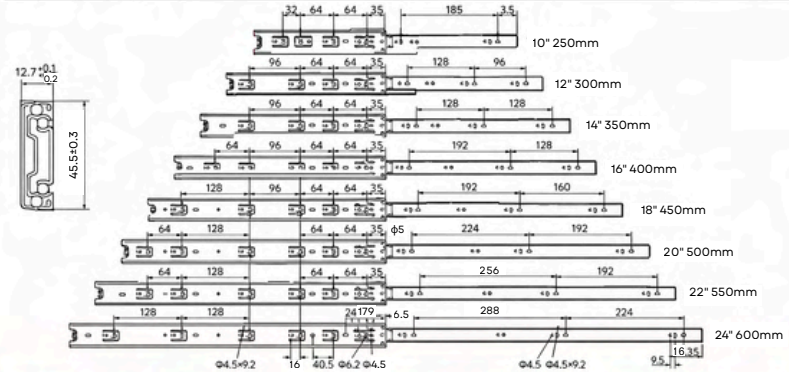

Item No.	4511-10	4511-12	4511-14	4511-16	4511-18	4511-20	4511-22	4511-24
Slide Length	250(10")	300(12")	350(14")	400(16")	450(18")	500(20")	550(22")	600(24")
Drawer Length	250	300	350	400	450	500	550	600
Min Cabinet Depth	255	305	355	405	455	505	555	605
Packing Unit(set)/Box	10	10	10	10	10	10	10	10

PRODUCT NAME	SKU
8" Ball Bearing Slide - Standard	4511-200
10" Ball Bearing Slide - Standard	4511-250
12" Ball Bearing Slide - Standard	4511-300
14" Ball Bearing Slide - Standard	4511-350
16" Ball Bearing Slide - Standard	4511-400
18" Ball Bearing Slide - Standard	4511-450
20" Ball Bearing Slide - Standard	4511-500
22" Ball Bearing Slide - Standard	4511-550
24" Ball Bearing Slide - Standard	4511-600
26" Ball Bearing Slide - Standard	4511-650
28" Ball Bearing Slide - Standard	4511-700

Push Open Side Mount Slide

Push Open Side Mount Slide

System SKU: 4558



PRODUCT SPECIFICATION:

- Product Length: 300mm - 600mm (12" - 24")
- Dynamic load capacity: 100lb (45kg)/ 18"
- Color: Blue zinc / Black
- Thickness: 1.2mm x 1.2mm x 1.4mm
- Lifetime test: 50,000+ cycles
- Packaging: 10 pairs per carton

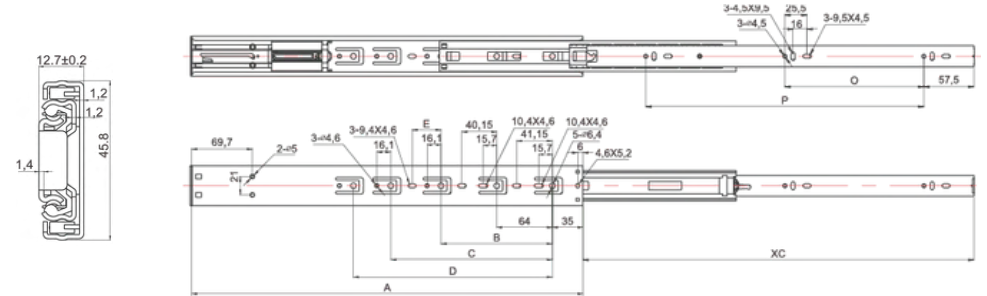

PRODUCT NAME	SKU
12" Side Mount Push Open Slides	4558-300
14" Side Mount Push Open Slides	4558-350
16" Side Mount Push Open Slides	4558-400
18" Side Mount Push Open Slides	4558-450
20" Side Mount Push Open Slides	4558-500
22" Side Mount Push Open Slides	4558-550

(STANDARD DUTY - 100 LB)

**KCMA-BIFMA-BHMA
CERTIFIED GRADE - 1**

System SKU: SY4512



(STANDARD DUTY - 100 LB)

**KCMA-BIFMA-BHMA
CERTIFIED GRADE - 1**

PRODUCT SPECIFICATION:

- Heavy Gauge Zinc Plated Steel Construction
- Soft Close Mechanism
- 32mm Hole Pattern
- Ball Bearing Carriage Hold Out Feature
- 1/2" Side Clearance
- 100 lb KCMA / BIFMA / BHMA Tested



PRODUCT NAME	SKU
10" P2 - Side Mount Soft Close Slides	4512-250
12" P2 - Side Mount Soft Close Slides	4512-300
14" P2 - Side Mount Soft Close Slides	4512-350
16" P2 - Side Mount Soft Close Slides	4512-400
18" P2 - Side Mount Soft Close Slides	4512-450
20" P2 - Side Mount Soft Close Slides	4512-500
22" P2 - Side Mount Soft Close Slides	4558-450
24" P2 - Side Mount Soft Close Slides	4512-600
26" P2 - Side Mount Soft Close Slides	4515-650
28" P2 - Side Mount Soft Close Slides	4512-700

System SKU: SY51



PRODUCT SPECIFICATION:

- Heavy Gauge Zinc Plated Steel Construction
- Soft Close Mechanism
- 32mm Hole Pattern
- Ball Bearing Carriage Hold Out Feature
- 1/2" Side Clearance
- 100 lb KCMA / BIFMA / BHMA Tested



(HEAVY DUTY - 150 LB)

**KCMA-BIFMA-BHMA
CERTIFIED GRADE - 1**

PRODUCT NAME	SKU
10" P2 - Side Mount Soft Close Slides	4512-250
12" P2 - Side Mount Soft Close Slides	4512-300
14" P2 - Side Mount Soft Close Slides	4512-350
16" P2 - Side Mount Soft Close Slides	4512-400
18" P2 - Side Mount Soft Close Slides	4512-450
20" P2 - Side Mount Soft Close Slides	4512-500
22" P2 - Side Mount Soft Close Slides	4558-450
24" P2 - Side Mount Soft Close Slides	4512-600
26" P2 - Side Mount Soft Close Slides	4515-650
28" P2 - Side Mount Soft Close Slides	4512-700

S-Flow Side mount Soft Close Slides

S-Flow Side mount Soft Close Slides

System SKU: 4565

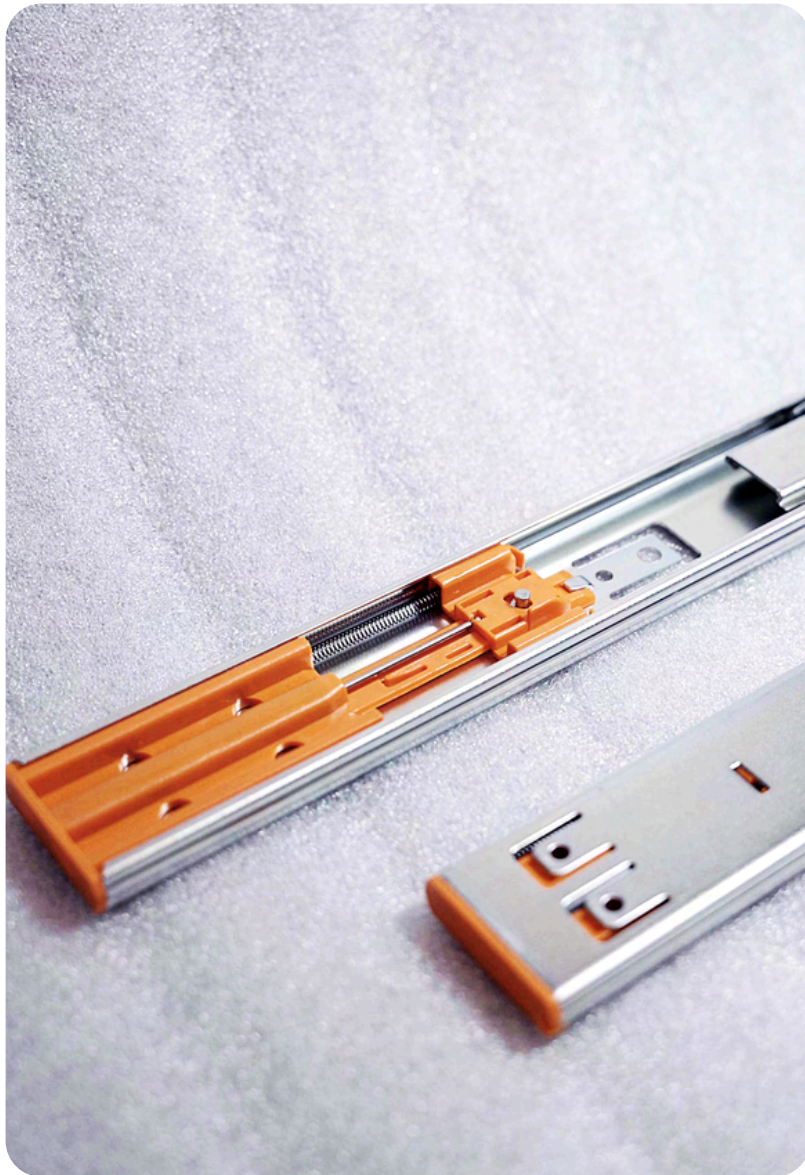

(DOUBLE SPRING)

**KCMA-BIFMA-BHMA
CERTIFIED GRADE - 1**

PRODUCT SPECIFICATION:

- Product Length: 250mm - 700mm (10"-28")
- Dynamic load capacity: 100lb (45kg / 18")
- Color: Blue zinc/ black (on request)
- Thickness: 1.2mm x 1.2mm x 1.5mm
- Lifetime test: 50,000+ cycles
- Packaging: 10 pairs per carton

Drawing description

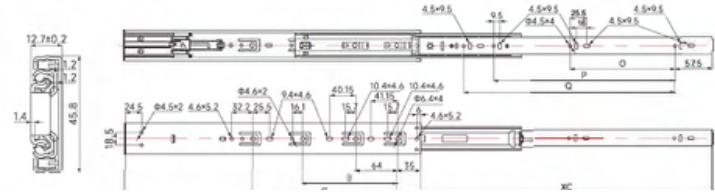

Product #	Size	A0-0.3	B±0.2	C±0.2	XC±0.3	O±0.2	P±0.2	Q±0.2
4565-300HH	12"	300			261	64		
4565-350HH	14"	350			345	96		
4565-400HH	16"	400	192		395	160		
4565-450HH	18"	450	224		445	160		
4565-500HH	20"	500	224		500	192		
4565-550HH	22"	550	224	320	550	224	352	
4565-600HH	24"	600	224	352	600	256		416

PRODUCT NAME	SKU
10" P1 Side Mount Soft Close Slides	4565-250
12" P1 Side Mount Soft Close Slides	4565-300
14" P1 Side Mount Soft Close Slides	4565-350
16" P1 Side Mount Soft Close Slides	4565-400
18" P1 Side Mount Soft Close Slides	4565-450
20" P1 Side Mount Soft Close Slides	4565-500
22" P1 Side Mount Soft Close Slides	4565-550
24" P1 Side Mount Soft Close Slides	4565-600
26" P1 Side Mount Soft Close Slides	4565-650
28" P1 Side Mount Soft Close Slides	4565-700



SM-RMB-500M

Side Mount Rear
Mounting Bracket - Metal



SM-RMB-100M

Side Mount Rear
Mounting Bracket - Metal



SM-FMB-100

Side Mount Front
Mounting Bracket - Metal



SM-RMB-200

Side Mount Rear Mounting
Bracket - Metal With Dowel
(10mm)



SM-RMB-400

Side Mount Rear Mounting
Bracket - Metal With Dowel
(8mm)



SM-RMB-600

Side Mount Adjustable Rear
Mounting Bracket - Left &
Right

COMPATIBLE WITH:

- SY4510 - Heavy Duty Ball Bearing Side Mount
- SY4511 - Self-Close Side Mount P2
- SY4512 - Soft Close Side Mount P2
- SY4565 - Soft Close Side Mount P1
- SY4558 - Push Open Side Mount

Faceframe Clip-On Soft-Close 3D Hinge

Faceframe Clip-On Soft-Close 3D Hinge

System SKU: SY328



- PRODUCT SPECIFICATION:**
- Opening angle: 105
 - Closing type: Soft close
 - Application: Face Frame
 - Diameter of hinge cup: 35mm
 - Height of hinge cup: 11.5mm
 - Boring distance range: 3-7mm
 - Distance of cup holes centers: 45mm
 - Door thickness: 14-21mm
 - Finishing: Nickel plated
 - Main material: Cold-rolled steel
 - Material thickness: 0.8-1.2-1.2mm

**KCMA-BIFMA-BHMA
CERTIFIED GRADE - 1**

CLIP-ON SOFT-CLOSE 3D HINGES

Full Overlay

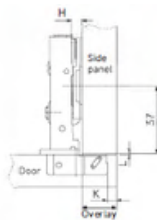

H=14+K-Overlay

H	K	3	4	5	6	7
0	17	18	19	20	21	
2	15	16	17	18	19	
4	13	14	15	16	17	

Abbreviations
K-boring distance W-Sidepanel width
H-Plate height T-door thickness

Half Overlay

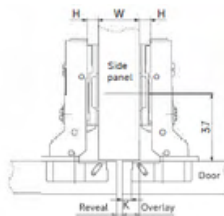

H=4+K-Overlay

H	K	3	4	5	6	7
0	7	8	9	10	11	
2	5	6	7	8	9	
4	3	4	5	6	7	

Abbreviations
K-boring distance W-Sidepanel width
H-Plate height T-door thickness

Inset

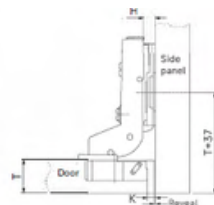

H=-4+K+Reveal

H	K	3	4	5	6	7
0	1	0	-1	-2	-3	
2	3	2	1	0	-1	
4	5	4	3	2	1	

Abbreviations
K-boring distance W-Sidepanel width
H-Plate height T-door thickness

Hinges per door

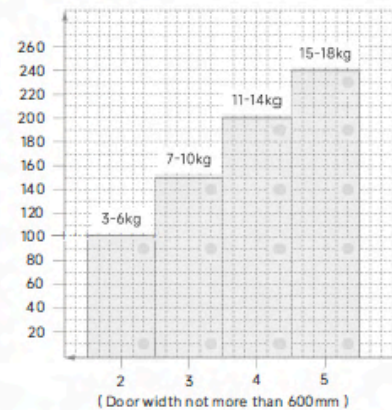

Application

Dimension of hinge cup

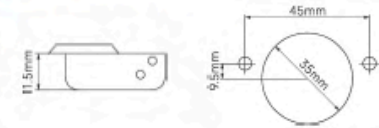

Door adjustment

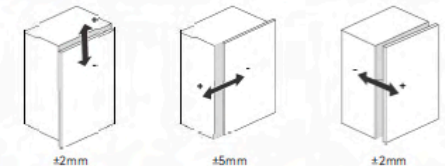

Mounting-plate



H0
0 mm Cam Adj
Zinc Die Cast Plate
for Faceframe Hinge



H3
3 mm Cam Adj
Zinc Die Cast Plate
for Faceframe Hinge



H6
6 mm Cam Adj
Zinc Die Cast Plate
for Faceframe Hinge



0 mm Steel 3D Cam
Adj Plate
328M-00P



3 mm Steel 3D Cam
Adj Plate
328M-03P

PRODUCT NAME	SKU
Clip-On Hinge, Regular, Full Overlay, Screw on	328-1AF
Clip-On Hinge, Regular, Full Overlay, With Dowel	328-1BF
Clip-On Hinge Soft Close, Full Overlay, Screw On	328-2AF
Clip-On Hinge Soft Close, Full Overlay, with Dowel	328-2BF
0 mm Mounting Plate for clip-on Hinge	328-00P
3 mm Mounting Plate for clip-on Hinge	328-03P
6 mm Mounting Plate for clip-on Hinge	328-06P
0 mm Steel 3D Cam Adj Plate	328M-00P
3 mm Steel 3D Cam Adj Plate	328M-03P

System SKU: SY301 (Soft Close)



PRODUCT SPECIFICATION:

- Opening angle: 105
- Closing type: Soft close
- Application: Frameless
- Diameter of hinge cup: 35mm
- Height of hinge cup: 10.5mm
- Boring distance range: 2.5mm
- Distance of cup holes centers: 45mm
- Door thickness: 14-21mm
- Finishing: Nickel plated
- Main material: Cold-rolled steel
- Material thickness: 0.8-1.2-1.2mm

**KCMA-BIFMA-BHMA
CERTIFIED GRADE - 1**

COMPACT 3D HINGE

1/2" Overlay

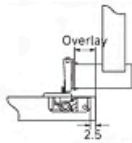

Size	Overlay
1/2"	12.7mm

3/4" Overlay

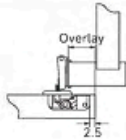

Size	Overlay
3/4"	19mm

1" Overlay



Size	Overlay
1"	25.4mm

1 1/4" Overlay

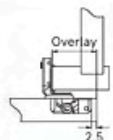

Size	Overlay
1 1/4"	31.8mm

Hinges per door

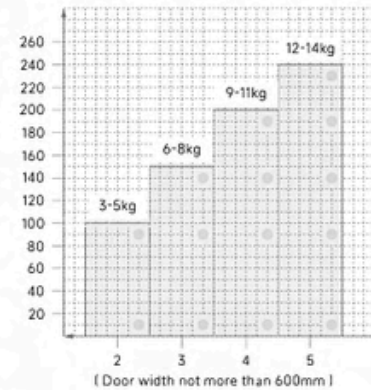

Dimension of hinge cup

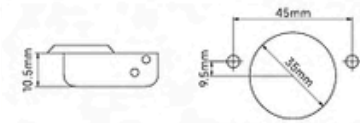

Door adjustment

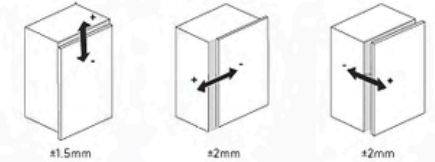

Mounting-plate

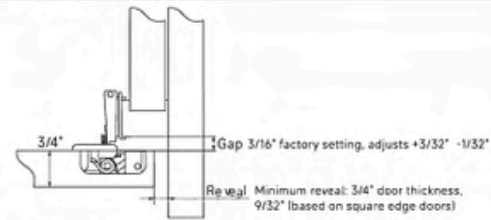

PRODUCT NAME	SKU
Compact Soft Close 3D Hinge, Press-in dowels (1 1/4" Overlay)	SY301-114D
Compact Soft Close 3D Hinge, Press-in dowels (1" Overlay)	SY301-100D
Compact Soft Close 3D Hinge, Press-in dowels (3/4" Overlay)	SY301-34D
Compact Soft Close 3D Hinge, Press-in dowels (1/2" Overlay)	SY301-12D
Compact Soft Close 3D Hinge (1 1/4" Overlay)	SY301-114
Compact Soft Close 3D Hinge (1" Overlay)	SY301-100
Compact Soft Close 3D Hinge (3/4" Overlay)	SY301-34
Compact Soft Close 3D Hinge (1/2" Overlay)	SY301-12

System SKU: SY301R (Regular)



PRODUCT SPECIFICATION:

- Opening angle: 105
- Closing type: Regular
- Application: Frameless
- Diameter of hinge cup: 35mm
- Height of hinge cup: 10.5mm
- Boring distance range: 2.5mm
- Distance of cup holes centers: 45mm
- Door thickness: 14-21mm
- Finishing: Nickel plated
- Main material: Cold-rolled steel
- Material thickness: 0.8-1.2-1.2mm

**KCMA-BIFMA-BHMA
CERTIFIED GRADE - 1**

COMPACT 3D HINGE

1/2" Overlay

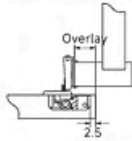

Size	Overlay
1/2"	12.7mm

3/4" Overlay

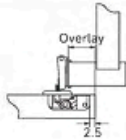

Size	Overlay
3/4"	19mm

1" Overlay



Size	Overlay
1"	25.4mm

1 1/4" Overlay

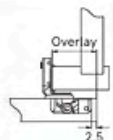

Size	Overlay
1 1/4"	31.8mm

Hinges per door

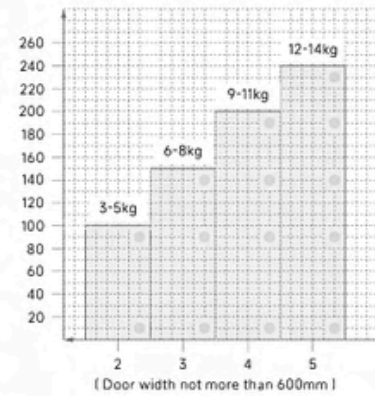

Dimension of hinge cup

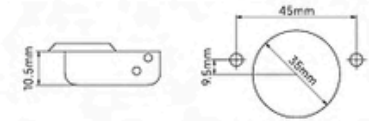

Door adjustment

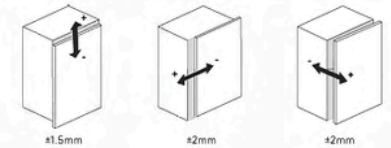

Mounting-plate

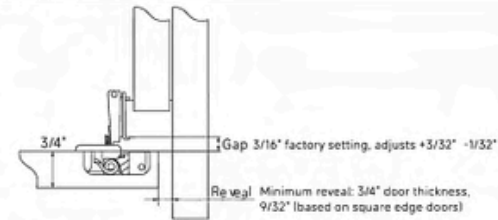

PRODUCT NAME	SKU
Compact Hinge - SY301 Series Self-Close, 1" Overlay, 3D Hinge, W/ Dowel	SY301R-100D
Compact Hinge - SY301 Series Self-Close, 1 1/2" Overlay, 3D Hinge, W/ Dowel	SY301R-112D
Compact Hinge - SY301 Series Self-Close, 1 1/4" Overlay, 3D Hinge, Screw On	SY301R-114
Compact Hinge - SY301 Series Self-Close, 1 1/4" Overlay, 3D Hinge, W/ Dowel	SY301R-114D
Compact Hinge - SY301 Series Self-Close, 1/2" Overlay, 3D Hinge, Screw On	SY301R-12
Compact Hinge - SY301 Series Self-Close, 1/2" Overlay, 3D Hinge, W/ Dowel	SY301R-12D

System SKU: SY711

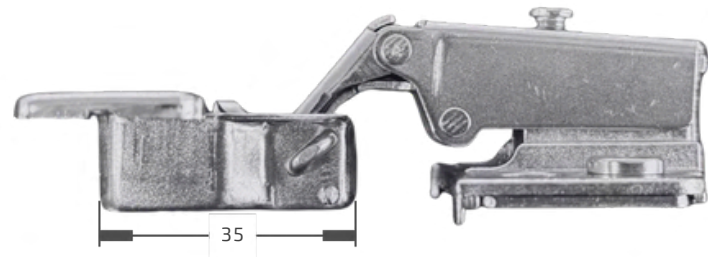
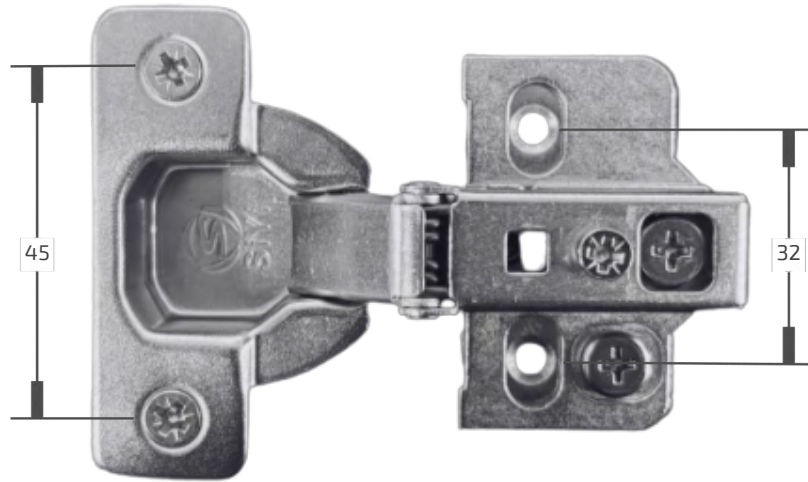

PRODUCT SPECIFICATION:

- Closing type: Self-Close/Soft-Close
- Cycles: 50,000+
- Hinge Cup Bore Depth: 12.5 mm
- Hinge Type: Compact
- Mount Centers: 45 mm
- Cabinet Type: Face Frame
- Degree of Opening: 125°
- Overlay: 1/2"
- Adjustment Type: Cam
- Hinge Cup: 35 mm
- Diameter Material: Die-cast
- Finish: Steel Nickle

Available Mounting Options



Dimensions of Hinge Cup

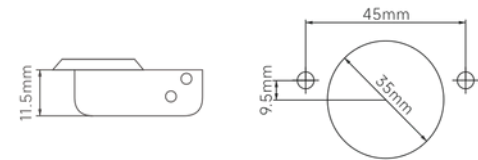

**KCMA-BIFMA-BHMA
CERTIFIED GRADE - 1**

PRODUCT NAME	SKU
1/2" Regular - Face frame Short Arm Hinge w/Dowel, 3D Cam Adjustment	711-12B1
1/2" Regular - Face frame Short Arm Hinge w/Screw On, 3D Cam Adjustment	711-12A1
1/2" Soft Close - Face frame Short Arm Hinge w/Dowel, 3D Cam Adjustment	711-12B2
1/2" Soft Close - Face frame Short Arm Hinge w/Screw On, 3D Cam Adjustment	711-12A2

Clip on Lazy Susan Self-Close

System SKU: SY135

**KCMA-BIFMA-BHMA
CERTIFIED GRADE - 1**



PRODUCT SPECIFICATION:

- Opening angle: 135°
- Closing type: Self-close
- Application: Face frame / Frameless
- Diameter of hinge cup: 35mm
- Height of hinge cup: 11.3mm
- Boring distance range: 4mm
- Distance of cup holes centers: 45mm
- Door thickness: 18-21mm
- Finishing: Nickel plated
- Main material: Cold-rolled steel / Zinc alloy
- Material thickness: 0.8-zinc alloy-1.2mm

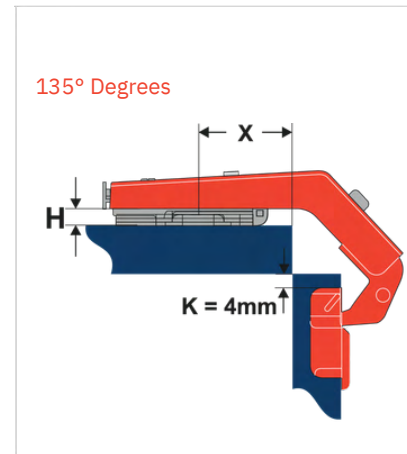

Dimension of hinge cup

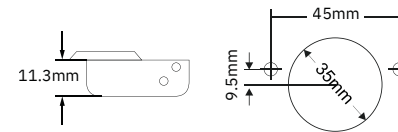

	Frameless	Face Frame
H	0mm	0mm
X	37mm	9.5mm

Mounting-plate

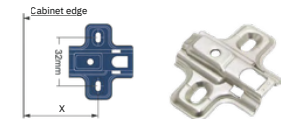

Pattern	H Value	Type
Two holes	H=0	Clip-on

Door adjustment

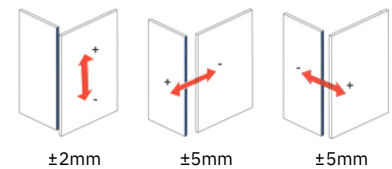

PRODUCT NAME	SKU
Corner Hinge Series Clip-On Self Close Lazy Susan Corner Hinge 135 Degree	SY135

System SKU: SY165

**KCMA-BIFMA-BHMA
CERTIFIED GRADE - 1**

PRODUCT SPECIFICATION:

- Opening angle: 135°
- Closing type: Self-close
- Application: Face frame / Frameless
- Diameter of hinge cup: 35mm
- Height of hinge cup: 11.3mm
- Boring distance range: 4mm
- Distance of cup holes centers: 45mm
- Door thickness: 18-21mm
- Finishing: Nickel plated
- Main material: Cold-rolled steel / Zinc alloy
- Material thickness: 0.8-zinc alloy-1.2mm

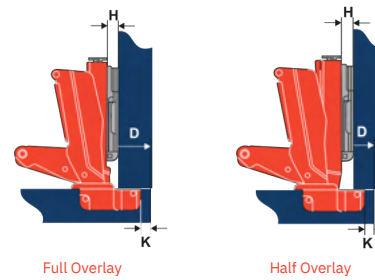
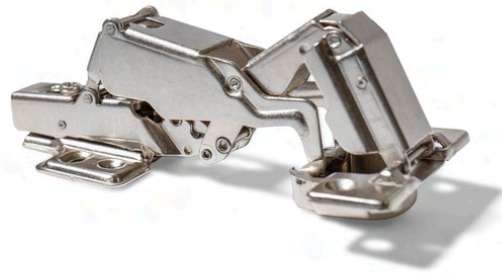
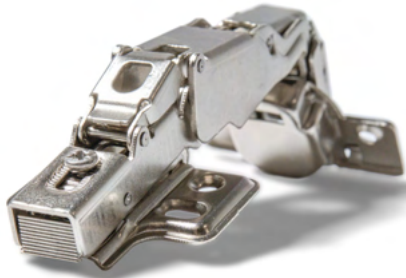

Mounting-plate

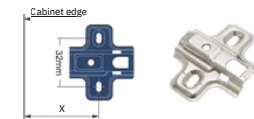

Pattern	H Value	Type
Two holes	H=0	Clip-on

Dimension of hinge cup

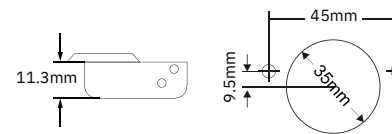

Door adjustment

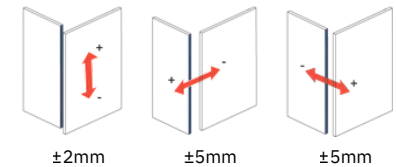

PRODUCT NAME	SKU
Corner Hinge Series Clip-On Soft Close Lazy Susan Corner Hinge 165 Degree	SY165





System SKU: LB82BL

Product Parameters



- Length: 270mm - 550mm
- Dynamic load capacity: 74.9lb / 18"
- Features: Full extension; silent operation; tool-free assembly & drawer removal
- Panel adjustment: Up and Down, Left and Right
- Lifetime test: 50,000+ cycles

Color		
Code	RAL Code	Color Name
9007	RAL 9007	Dark Grey
9016	RAL 9016	Pearl White
7042	RAL 7042	Light Grey

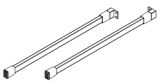
Bulk Packaging			
Description	Part Number		
1 82 Drawer Box Slide 	Set		
	LB82BLHG-270		
	LB82BLHG-300		
	LB82BLHG-350		
	LB82BLHG-400		
	LB82BLHG-450		
LB82BLHG-500			
LB82BLHG-550			
2 Drawer Side Board 	Set		
	LB82BLCB-270	LB82BLCB-450	
	LB82BLCB-300	LB82BLCB-500	
	LB82BLCB-350	LB82BLCB-550	
	LB82BLCB-400		
3 Front Connector 	Set		
	TJ-250		
4 Cover Cap 	Set		
	SL-303		
5 Rear Connector (L) 	Set		
	TJ-229		
6* Galleries 	Set		
	TJ-273	TJ-277	
	TJ-274	TJ-278	
	TJ-275	TJ-279	
	TJ-276		

Height: L - 4" (101.6 mm)

Complete Drawer System Packages	
Size (mm)	Part Number
270	LB82BL-270
300	LB82BL-300
350	LB82BL-350
400	LB82BL-400
450	LB82BL-450
500	LB82BL-500
550	LB82BL-550

Each Set Includes:

1. 82 Drawer Box Slide x 1 Set
2. Drawer Slide Board (L/R) x 1 Set
3. Front Connector (L/R) x 1 Pair
4. Cover Cap x 1 Pair
5. Rear Connector or (L) x 1 Pair
6. M-Galleries (Rect.) x 2 Pcs
7. H-Galleries (Rect.) x 4 Pcs

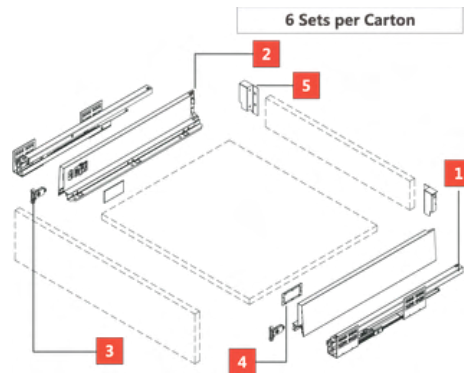

Low drawer = L Height

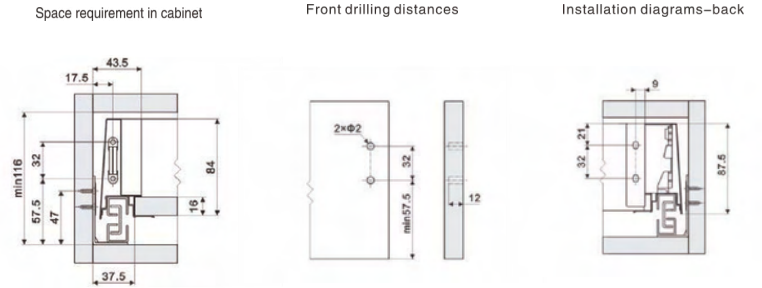

W: internal cabinet width NL: nominal slide length

(Low Drawer: L Height)

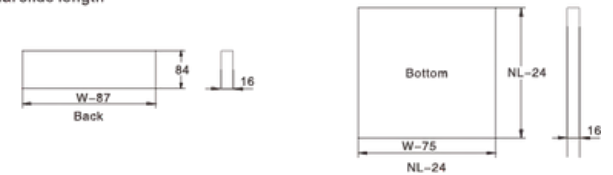

Cabinet profile / screw positions

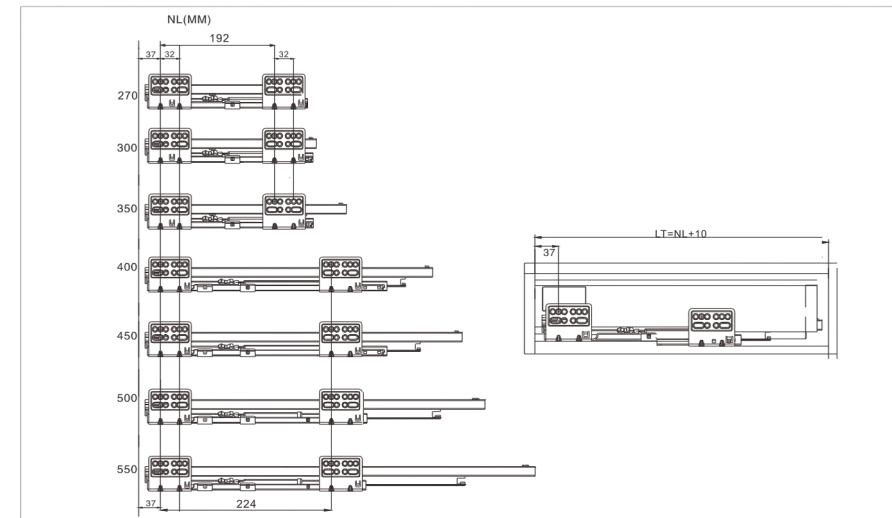

System SKU: LB82BM

Product Parameters



- Length: 270mm - 550mm
- Dynamic load capacity: 74.9lb / 18"
- Features: Full extension; silent operation; tool-free assembly & drawer removal
- Panel adjustment: Up and Down, Left and Right
- Lifetime test: 50,000+ cycles

Color		
Code	RAL Code	Color Name
9007	RAL 9007	Dark Grey
9016	RAL 9016	Pearl White
7042	RAL 7042	Light Grey





Height: L - 5" (127 mm)

Complete Drawer System Packages	
Size (mm)	Part Number
270	LB82BM-270
300	LB82BM-300
350	LB82BM-350
400	LB82BM-400
450	LB82BM-450
500	LB82BM-500
550	LB82BM-550

Each Set Includes :

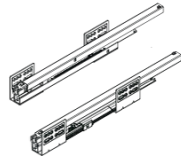
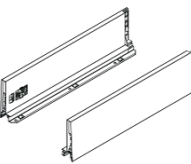
1. 82Drawer Box Slide	x 1 Set
2. Drawer Side Board	x 1 Set
3. Front Connector	x 1 Pair
4. Cover Cap	x 1 Pair
5. Rear Connector (M)	x 1 Pair

6 Sets per Carton

Bulk Packaging	
Description	Part Number
1 82 Drawer Box Slide Set 	LB82AHG-270
	LB82AHG-300
	LB82AHG-350
	LB82AHG-400
	LB82AHG-450
	LB82AHG-500
LB82AHG-550	
2 Drawer Side Board Set 	LB82BMCB-270
	LB82BMCB-300
	LB82BMCB-350
	LB82BMCB-400
	LB82BMCB-450
	LB82BMCB-500
LB82BMCB-550	
3 Front Connector Set 	TJ-250
4 Cover Cap Set 	SL-303
5 Rear Connector (M) Set 	TJ-229

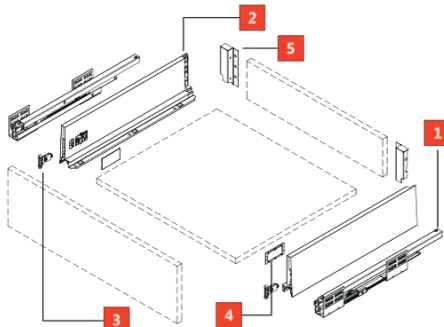

Low drawer = M Height

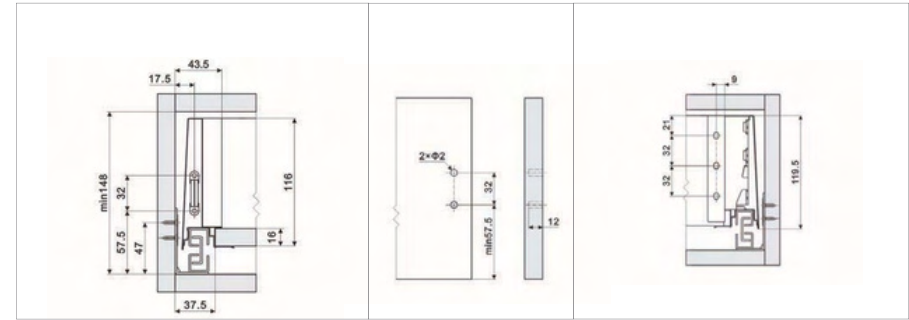

W: internal cabinet width NL: nominal slide length

(Mid Drawer: M Height)

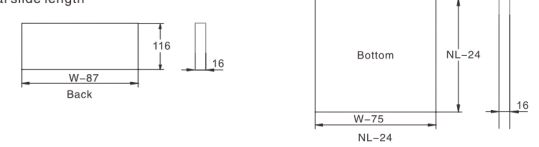

Cabinet profile / screw positions

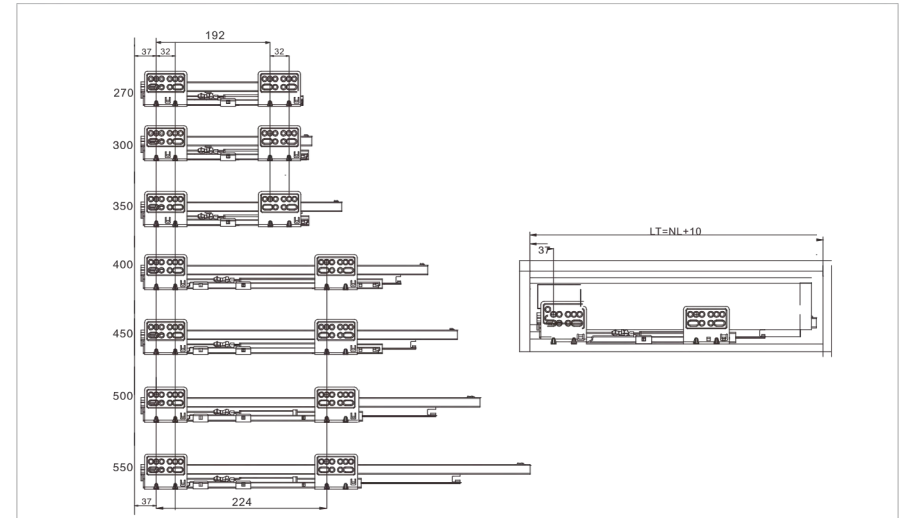

Millimeter to inch Conversion Chart

System SKU: SYC



PRODUCT SPECIFICATION:

- Uses standard 12-gallon & up trash bags
- Perfect for separating recycling and trash
- Once installed, the unit can be removed for easy cleaning
- Designed for cabinet opening width of 14"
- This unit holds 100 lbs.
- Designed for 18 Base Cabinets (Face frame & Frameless)

PRODUCT NAME	SKU
Kitchen Accessories 35QT Gray Waste Container - 1 PCS	SYCR35-18G
Kitchen Accessories 35QT White Waste Container - 1 PCS	SYCR35-18W
Kitchen Accessories 50QT Gray Waste Container - 1 PCS	SYCR50-18G
Kitchen Accessories 50QT White Waste Container - 1 PCS	SYCR50-18W

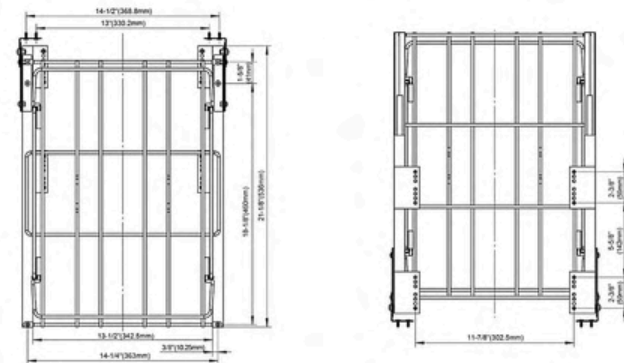
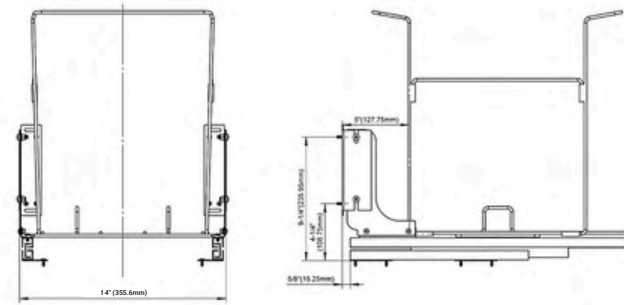

System SKU: SYMA-SO-15



PRODUCT SPECIFICATION:

- Will work in a full-height or door/drawer blind corner cabinet
- Textured Orion Gray Surface and flat wire design
- Construction: Heavy-duty metal frame with solid bottom surface
- This unit holds 45 lbs. Per Shelf
- Cabinet Floor/Side Mounted

PRODUCT NAME	SKU
Kitchen Accessories Left Maximo Blind Corner Swing Out	SYMA-SO-15L
Kitchen Accessories Right Maximo Blind Corner Swing Out	SYMA-SO-15R

System SKU: SY360

**DESCRIPTION:**

Maximize your kitchen's potential with this 360-degree Lazy Susan system, engineered to transform corner cabinets into accessible storage. The set features two independently rotating shelves crafted from high-impact polymer with reinforced ribbing, supported by a customizable telescoping pole. Built for long-term durability, this unit exceeds BHMA Class-1 standards and comes complete with all necessary hardware and guides for a straightforward installation.

PRODUCT SPECIFICATION:

- 710* (535 - 960)
- 810* (535 - 960)
- Cabinet: 700 - 900 mm

PRODUCT NAME	SKU
18" Plastic Lazy Susan Set 360° (ROUND)	SY360-18P
24" Plastic Lazy Susan Set 360° (ROUND)	SY360-24P
28" Plastic Lazy Susan Set 360° (ROUND)	SY360-28P

(360° PLASTIC LAZY SUSAN)

System SKU: SY270

**DESCRIPTION:**

This 270-degree Lazy Susan system is engineered to make corner cabinets more accessible. The set features two independently rotating shelves crafted from high-impact polymer with reinforced ribbing, supported by a customizable telescoping pole. Built for long-term durability, this unit exceeds BHMA Class-1 standards and comes complete with all necessary hardware and guides for an easy installation.

PRODUCT SPECIFICATION:

- 610* (535-960) 24"
- 710* (535-960) 28"
- Cabinet: 700 - 900 mm

PRODUCT NAME	SKU
24" Plastic Lazy Susan Set 270° (KIDNEY)	SY270-24P
28" Plastic Lazy Susan Set 270° (KIDNEY)	SY270-28P
32" Plastic Lazy Susan Set 270° (KIDNEY)	SY270-32P

(270° PLASTIC LAZY SUSAN)

System SKU: SYUL68270

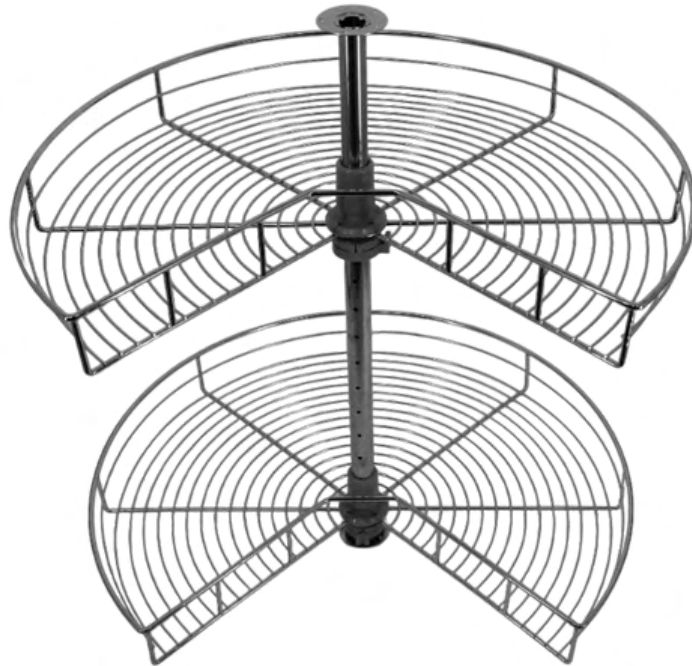

DESCRIPTION:

The dual-tier set features independently rotating shelves constructed from heavy-gauge steel wire, providing a sleek, modern look that remains exceptionally sturdy. With an adjustable telescoping center post and included mounting hardware, this professional-grade unit offers a durable, high-capacity organizational solution for any kitchen pantry.

PRODUCT SPECIFICATION:

- 710*(560-790)
- Cabinet: 700 - 900 mm

PRODUCT NAME	SKU
24" Metal Wire Lazy Susan Set 270° (KIDNEY)	SYUL68270-24M
28" Metal Wire Lazy Susan Set 270° (KIDNEY)	SYUL68270-28M
32" Metal Wire Lazy Susan Set 270° (KIDNEY)	SYUL68270-32M

(270° METAL WIRE LAZY SUSAN)

Corner Brace with Tabs and Boss - No Lip

System SKU: CB-2625-101

Corner Brace with Tabs and Boss - No Lip

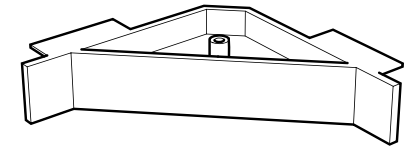
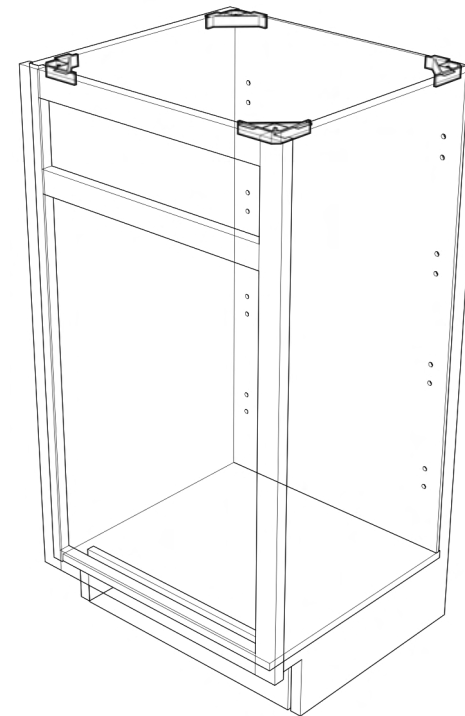
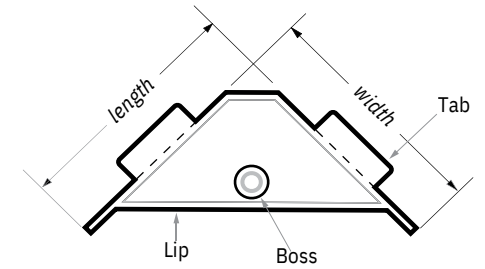
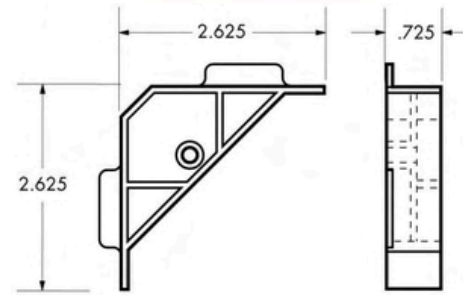

Corner Brace with Lip and Boss - No Tabs

System SKU: CB-2625-102

Corner Brace with Lip and Boss - No Tabs

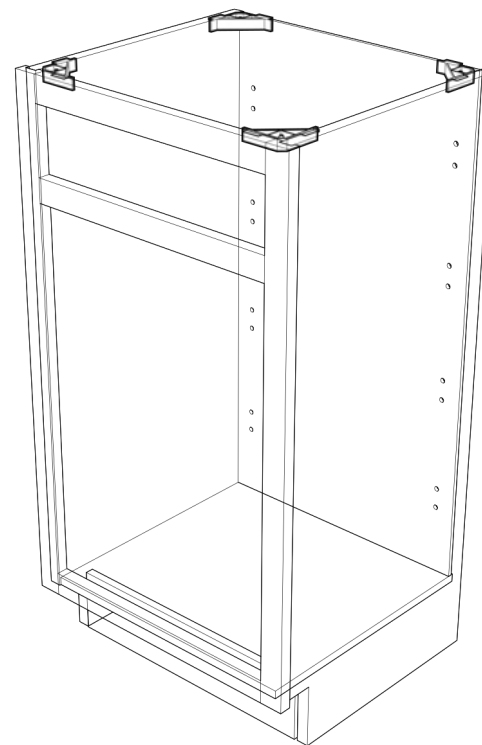
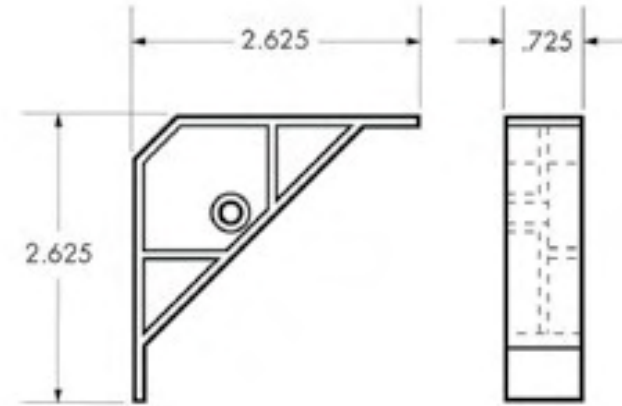
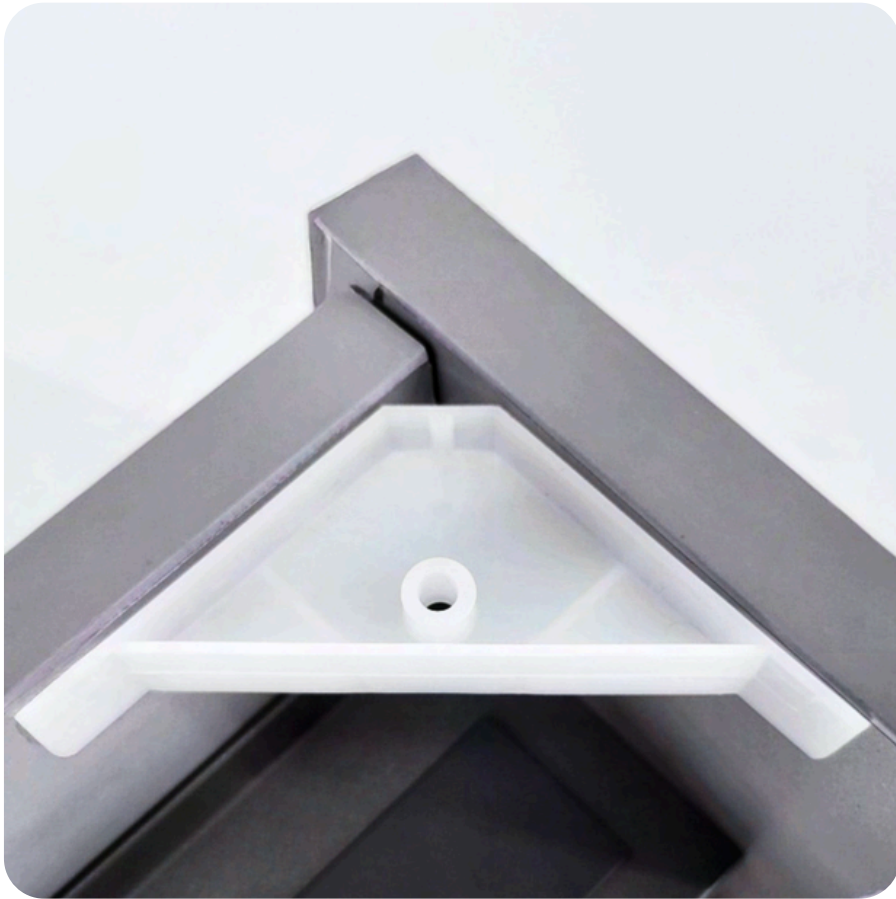

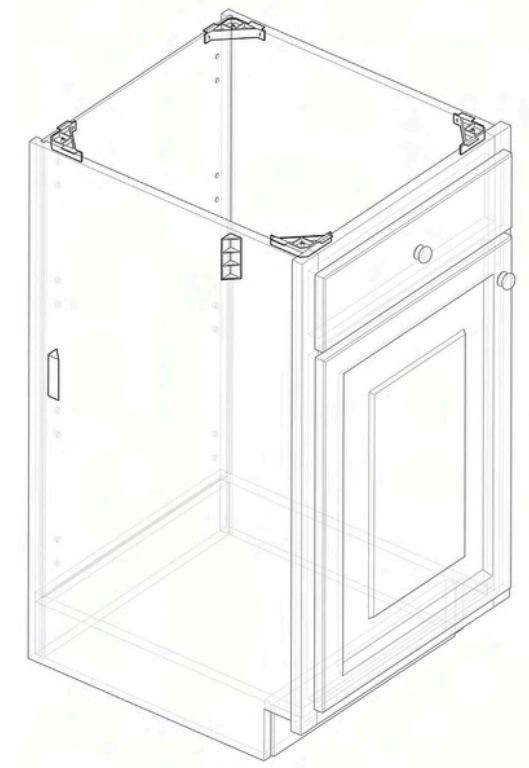
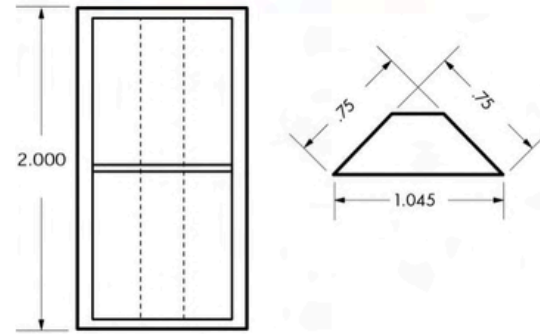
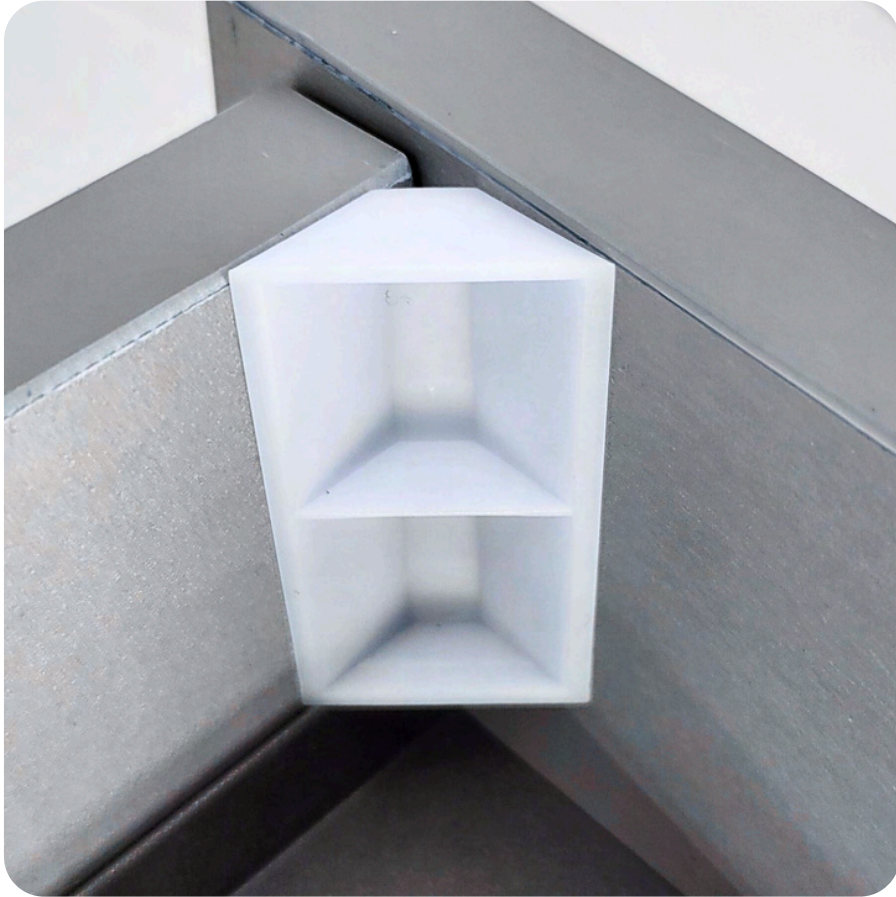

Dowel Locking Shelf Support

System SKU: DLSS-12 | DLSS-34 | DSLL-58

Dowel Locking Shelf Support

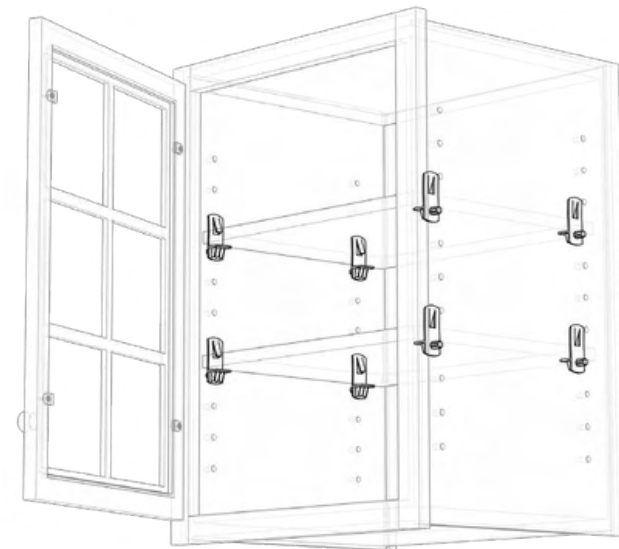
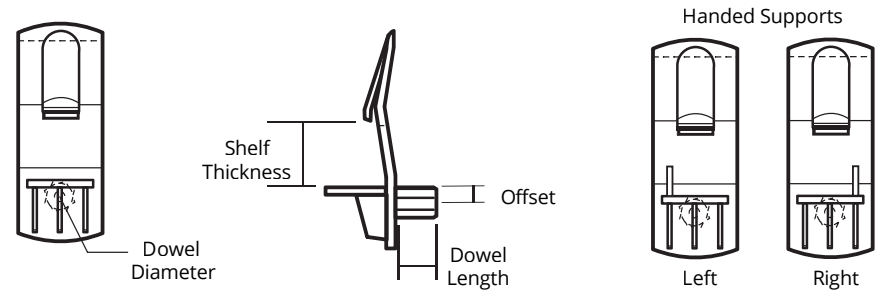

Product Name	SKU
0.250 Dowel Locking Shelf Support For 1/2" Shelves	DLSS-12
0.250 Dowel Locking Shelf Support For 3/4" Shelves	DLSS-34
0.250 Dowel Locking Shelf Support For 5/8" Shelves	DLSS-58